



EMC TEST REPORT

Issued for

Guangdong Ankuai Intelligent Technology Co., Ltd.

No. 106, Tangxia Section, Tangtian South Road, Tangxia
Town, Dongguan City, Guangdong Province, China

Product Name:	Flap barrier / Flap turnstile
Brand Name:	N/A
Model Name:	T312
Series Model:	T310,T311,T313,T314,T315,T316,T317,T318,T319
Test Standard:	EN55014-1: 2006+A1: 2009+A2: 2011 EN55014-2: 1997+A1: 2001+A2: 2008 EN 61000-3-2:2014 EN 61000-3-3:2013



TEST RESULT CERTIFICATION

Applicant's Name.....: Guangdong Ankuai Intelligent Technology Co., Ltd.
Address.....: No. 106, Tangxia Section, Tangtian South Road, Tangxia Town, Dongguan City, Guangdong Province, China
Manufacture's Name.....: Guangdong Ankuai Intelligent Technology Co., Ltd.
Address.....: No. 106, Tangxia Section, Tangtian South Road, Tangxia Town, Dongguan City, Guangdong Province, China

Product Description

Product Name.....: Flap barrier / Flap turnstile
Brand Name: N/A
Model Name.....: T312
Series Model.....: T310,T311,T313,T314,T315,T316,T317,T318,T319
Test Standards.....: EN55014-1: 2017/A11:2010 EN55014-2: 2015
EN 61000-3-3:2013/A1:2019 EN 61000-3-2:2019

This device described above has been tested by FCS, and the test results show that the equipment under test (EUT) is in compliance with the EMC Directive 2014/30/EU requirements. And it is applicable only to the tested sample identified in the report. This report shall not be reproduced except in full, without the written approval of FCS, this document may be altered or revised by FCS, personal only, and shall be noted in the revision of the document.

Date of Test.....:
Date (s) of performance of tests : 27 Oct. 2020 ~03 Nov. 2020
Date of Issue.....: 03 Nov. 2020
Test Result.....: Pass

Tested by : Scott Shen
(Scott Shen)
Reviewed by : Duke Qian
(Duke Qian)
Approved by : Kait Chen
(Kait Chen)



**TABLE OF CONTENTS**

1. TEST SUMMARY	5
1.1 TEST FACTORY.....	6
1.2 MEASUREMENT UNCERTAINTY.....	6
2. GENERAL INFORMATION	7
2.1 GENERAL DESCRIPTION OF THE EUT.....	7
2.2 DESCRIPTION OF THE TEST MODES.....	8
2.3 DESCRIPTION OF THE TEST SETUP.....	8
2.4 DESCRIPTION TEST PERIPHERAL AND EUT PERIPHERAL.....	9
2.5 MEASUREMENT INSTRUMENTS LIST.....	10
3. EMC EMISSION TEST	13
3.1 CONDUCTED EMISSION MEASUREMENT.....	13
3.2 RADIATED EMISSION MEASUREMENT.....	17
3.3 HARMONICS CURRENT.....	21
3.4 VOLTAGE FLUCTUATION AND FLICKERS.....	24
4. EMC IMMUNITY TEST	26
4.1 STANDARD COMPLIANCE/SERVIRITY LEVEL/CRITERIA.....	26
4.2 GENERAL PERFORMANCE CRITERIA.....	27
4.3 ELECTROSTATIC DISCHARGE IMMUNITY TEST (ESD).....	28
4.4 RADIATED, RADIO-FREQUENCY, ELECTROMAGNETIC FIELD IMMUNITY TEST (RS)....	31
4.5 ELECTRICAL FAST TRANSIENT (EFT).....	34
4.6 SURGE TESTING.....	38
4.7 CONDUCTED RADIO FREQUENCY DISTURBANCES (CS).....	41
4.8 VOLTAGE INTERRUPTION/DIPS TESTING (DIPS).....	45
APPENDIX 1- TEST SETUP	47



Revision History

Rev.	Issue Date	Report No.	Effect Page	Contents
00	03 Nov. 2020	FCS202010029E02	ALL	Initial Issue

1. TEST SUMMARY

Test procedures according to the technical standards:

EMC Emission				
Standard	Test Item	Limit	Judgment	Remark
EN55014-1: 2017/A11:2010	Conducted Emissions From The AC Mains Power Ports	Class B	PASS	
	Conducted Emissions From Asymmetric Mode	Class B	N/A	
	Conducted Differential Voltage Emissions	Class B	N/A	
	Radiated Emissions	Class B	PASS	
EN61000-3-2:2014	Harmonic Current Emission	Class A	PASS	NOTE (1)
EN61000-4-3:2006/A2:2010	Voltage Fluctuations & Flicker	-----	PASS	
EMC Immunity				
Section	Test Item	Performance Criteria	Judgment	Remark
EN 61000-4-2:2009	Electrostatic Discharge	B	PASS	
EN 61000-4-3:2006/A2:2010	RF Electromagnetic Field	A	PASS	
EN 61000-4-4:2012	Fast Transients	B	PASS	
EN 61000-4-5:2014/A1:2017	Surges	B	PASS	
EN 61000-4-6:2014/AC:2015	Radio-frequency Common Mode / Conducted Susceptibility	A	PASS	
EN 61000-4-11:2020	Volt. Interruptions Volt. Dips	B / C / C	PASS	NOTE (2)

Note:

- (1) The power consumption of EUT is less than 75W and no Limits apply.
- (2) Voltage Dip: 100% reduction – Performance Criteria **B**
 Voltage Dip: 30% reduction – Performance Criteria **C**
 Voltage Interruption: 100% Interruption – Performance Criteria **C**
- (3) For client’s request and manual description, the test will not be executed.
- (4) “N/A” denotes test is not applicable in this Test Report



1.1 TEST FACTORY

Company Name:	Flux Compliance Service Laboratory.
Address:	Room 105 Floor Bao hao Technology Building 1 NO.15 Gong ye West Road Hi-Tech Industrial, Song shan lake Dongguan,

1.2 MEASUREMENT UNCERTAINTY

The reported uncertainty of measurement $y \pm U$, where expanded uncertainty U is based on a standard uncertainty multiplied by a coverage factor of $k=2$, providing a level of confidence of approximately **95** %.

A. Conducted Measurement:

Test Site	Method	Measurement Frequency Range	U, (dB)	NOTE
FCSC01	ANSI	9KHz ~ 150KHz	3.18	
		150 KHz ~ 30MHz	2.70	

B. Radiated Measurement:

Test Site	Method	Measurement Frequency Range	U, (dB)	NOTE
FCSC02	ANSI	9KHz ~ 30MHz	2.50	
		30MHz ~ 200MHz	3.43	
		200MHz ~ 1000MHz	3.57	
		1GHz ~ 6 GHz	4.13	

2. GENERAL INFORMATION

2.1 GENERAL DESCRIPTION OF THE EUT

Product Name	Flap barrier / Flap turnstile
Brand Name	N/A
Model Name	T312
Series Name	T310,T311,T313,T314,T315,T316,T317,T318,T319
Product Differences	Only different in brand, color and model name
Power Supply	Input:230V,50Hz Output:DC 24V
Hardware version number	V1.0
Software version number	V1.0

2.2 DESCRIPTION OF THE TEST MODES

To investigate the maximum EMI emission characteristics generates from EUT, the test system was pre-scanning tested base on the consideration of following EUT operation mode or test configuration mode which possible have effect on EMI emission level. Each of these EUT operation mode(s) or test configuration mode(s) mentioned above was evaluated respectively.

Test Mode	Description
Mode 1	Charging

Note: The test modes were carried out for all operation modes. Only worst case will be show in this report.

2.3 DESCRIPTION OF THE TEST SETUP

Mode 1:

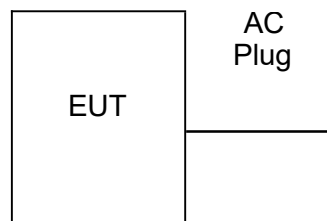

2.4 DESCRIPTION TEST PERIPHERAL AND EUT PERIPHERAL

The EUT has been tested as an independent unit together with other necessary accessories or support units. The following support units or accessories were used to form a representative test configuration during the tests.

Accessories equipment

Mode 1:

Item	Equipment	Mfr/Brand	Model/Type No.
E-1			

Auxiliary equipment

Mode 2:

Item	Equipment	Mfr/Brand	Model/Type No.

Cable

Mode 1:

Item	Type	Shielded Type	Ferrite Core	Length
C-1				

Mode 2:

Item	Type	Shielded Type	Ferrite Core	Length

Note:

- (1) The support equipment was authorized by Declaration of Confirmation.
- (2) For detachable type I/O cable should be specified the length in cm in 『Length』 column.
- (3) “YES” means “shielded” “with core”; “NO” means “unshielded” “without core”.

2.5 MEASUREMENT INSTRUMENTS LIST

2.5.1 CONDUCTED TEST SITE

Kind of Equipment	Manufacturer	Type No.	Serial No.	Last Calibration	Calibrated Until
EMI Test Receiver	R&S	ESCI	101427	2020.10.12	2021.10.12
LISN	R&S	ENV216	101242	2020.10.12	2021.10.12
LISN	ETS	3810/2NM	00023625	2020.10.12	2021.10.12
Absorbing Clamp	R&S	MDS-21	100668	2020.10.12	2021.10.12
Universal Radio Communication Tester	R&S	CMW500	117239	2020.10.12	2021.10.12
CE Cable	N/A	C01	N/A	2020.10.12	2021.10.12
Temperature & Humidity	Mieo	HH660	N/A	2020.10.12	2021.10.12
Testing Software	EZ-EMC(Ver.03A1 CE)				

2.5.2 RADIATED TEST SITE

Kind of Equipment	Manufacturer	Type No.	Serial No.	Last Calibration	Calibrated Until
EMI Test Receiver	R&S	ESCI	101427	2020.10.12	2021.10.12
Bi-log Antenna	TESEQ	CBL6111D	34678	2020.10.12	2021.10.12
Horn Antenna	SCHWARZBECK	BBHA 9120D	9120D-1343	2020.10.12	2021.10.12
Pre-amplifier(1G-18G)	SKET	LNPA-01018G-45	SK2018080901	2020.10.12	2021.10.12
Pre-amplifier(0.1M-3GHz)	EM	EM330	060665	2020.10.12	2021.10.12
Spectrum Analyzer	Agilent	N9020A	MY49100060	2020.10.12	2021.10.12
Universal Radio Communication Tester	R&S	CMW500	117239	2020.10.12	2021.10.12
RE Cable (9K-1G)	N/A	R01	N/A	2020.10.12	2021.10.12
RE Cable (1G-18G)	N/A	R02	N/A	2020.10.12	2021.10.12
Temperature & Humidity	Mieo	HH660	N/A	2020.10.12	2021.10.12
Testing Software	EZ-EMC(Ver. 03A1 RE)				

2.5.3 HARMONICS AND FLICKER

Kind of Equipment	Manufacturer	Type No.	Serial No.	Last Calibration	Calibrated Until
Harmonic Voltage & Flicker	LAPLACE	AC 2000A	311217	2020.10.12	2021.10.12
AC Power Source	MTONI	PHF-5010	631169	2020.10.12	2021.10.12
Universal Radio Communication Tester	R&S	CMW500	117239	2020.10.12	2021.10.12
Temperature & Humidity	Mieo	HH660	N/A	2020.10.12	2021.10.12

Testing Software	HA-PC Link Version 3.03
------------------	-------------------------

2.5.4 ESD

Kind of Equipment	Manufacturer	Type No.	Serial No.	Last Calibration	Calibrated Until
Electrostatic Discharge Simulator	KZKUSUI	KES4021	LB003568	2020.10.12	2021.10.12
Universal Radio Communication Tester	R&S	CMW500	117239	2020.10.12	2021.10.12
Temperature & Humidity	N/A	WS1066	N/A	2020.10.12	2021.10.12

2.5.5 SURGE, EFT/BURST, VOLTAGE INTERRUPTION/DIPS

Kind of Equipment	Manufacturer	Type No.	Serial No.	Last Calibration	Calibrated Until
Surger Generator	HTEC	HCWG 10	152101	2020.10.12	2021.10.12
Surger Generator	HTEC	TCOMB4	152104	2020.10.12	2021.10.12
VOLTAGE DIPS & INTERRUPTIONS Generator	HTEC	HPFS 161P	143803	2020.10.12	2021.10.12
EFT/B Generator	HTEC	HEFT 51	143801	2020.10.12	2021.10.12
Universal Radio Communication Tester	R&S	CMW500	117239	2020.10.12	2021.10.12
Temperature & Humidity	Mieo	HH660	N/A	2020.10.12	2021.10.12

2.5.6 RS

Kind of Equipment	Manufacturer	Type No.	Serial No.	Last Calibration	Calibrated Until
Power Meter	Agilent	E4419B	QB4331226	2020.10.12	2021.10.12
Power Sensor	Hp	E9300A	US39210170	2020.10.12	2021.10.12
Power Sensor	Hp	E9300A	US39210476	2020.10.12	2021.10.12
Signal Generator	Agilent	N5181A	MY56144718	2020.10.12	2021.10.12
Power Amplifier	MICOTOP	MPA-80-1000-250	MPA1711489	2020.10.12	2021.10.12
Power Amplifier	MICOTOP	MPA-1000-3000-75	MPA1711488	2020.10.12	2021.10.12
Power Amplifier	MICOTOP	MPA-3000-6000-50	MPA1711490	2020.10.12	2021.10.12
RS Test Antenna (80-1GHz)	SCHWARZBECK	VULP 9118E	000999	2020.10.12	2021.10.12
RS Test Antenna (1G-10GHz)	SCHWARZBECK	STLP 9149	000648	2020.10.12	2021.10.12
Universal Radio Communication Tester	R&S	CMU200	109200	2020.10.12	2021.10.12

Universal Radio Communication Tester	R&S	CMW500	117239	2020.10.12	2021.10.12
Audio Analyzer	R&S	UPL	100689	2020.10.12	2021.10.12
Audio Breakthrough Shielding Box	SKET	SB_ABT/C35	N/A	2020.10.12	2021.10.12
Ear Simulator	SKET	AE_ABT/C35	N/A	2020.10.12	2021.10.12
Mouth Simulator	SKET	AM_ABT/C35	N/A	2020.10.12	2021.10.12
1KHz Standard Source	SKET	MSC_ABT/C35	N/A	2020.10.12	2021.10.12
Field Probe	Narda	EP601	611WX80261	2020.10.12	2021.10.12
Temperature & Humidity	Mieo	HH660	N/A	2020.10.12	2021.10.12
Testing Software	EMC-S V1.2.0.90				

2.5.7 INJECTION CURRENT

Kind of Equipment	Manufacturer	Type No.	Serial No.	Last Calibration	Calibrated Until
CS	SCHLODER	CDG-6000-25	126A1280/2014	2020.10.12	2021.10.12
CDN	SCHLODER	CDN-M2+3	A2210275/2014	2020.10.12	2021.10.12
EM Clamp	SCHLODER	EMCL-20	132A1283	2020.10.12	2021.10.12
Attenuator	Nemtest	ATT-6DB-100	A100W224	2020.10.12	2021.10.12
Universal Radio Communication Tester	R&S	CMW500	117239	2020.10.12	2021.10.12
Universal Radio Communication Tester	R&S	CMU200	109200	2020.10.12	2021.10.12
Audio Analyzer	R&S	UPL	100689	2020.10.12	2021.10.12
Audio Breakthrough Shielding Box	SKET	SB_ABT/C35	N/A	2020.10.12	2021.10.12
Ear Simulator	SKET	AE_ABT/C35	N/A	2020.10.12	2021.10.12
Mouth Simulator	SKET	AM_ABT/C35	N/A	2020.10.12	2021.10.12
1KHz Standard Source	SKET	MSC_ABT/C35	N/A	2020.10.12	2021.10.12
Temperature & Humidity	Mieo	HH660	N/A	2020.10.12	2021.10.12

2.5.8 PFMF

Kind of Equipment	Manufacturer	Type No.	Serial No.	Last Calibration	Calibrated Until
MF Generator	HTEC	HMFG-COMB	143903	2020.10.12	2021.10.12
Magnetic Field Coil	HTEC	HCOIL 100	143808	2020.10.12	2021.10.12
Universal Radio Communication Tester	R&S	CMW500	117239	2020.10.12	2021.10.12
Temperature & Humidity	Mieo	HH660	N/A	2020.10.12	2021.10.12

3. EMC EMISSION TEST

3.1 CONDUCTED EMISSION MEASUREMENT

3.1.1 REQUIREMENTS FOR CONDUCTED EMISSIONS FROM THE AC MAINS POWER PORTS OF THE CLASS A EQUIPMENT

FREQUENCY (MHz)	Coupling device	Detector type / bandwidth	Class A limits dB(μ V)
0.15 - 0.5	AMN	Quasi Peak / 9 kHz	79
0.50 - 30			63
0.15 - 0.5	AMN	Average / 9 kHz	66
0.50 - 30			60

3.1.2 REQUIREMENTS FOR CONDUCTED EMISSIONS FROM THE AC MAINS POWER PORTS OF THE CLASS B EQUIPMENT

FREQUENCY (MHz)	Coupling device	Detector type / bandwidth	Class B limits dB(μ V)
0.15 - 0.5	AMN	Quasi Peak / 9 kHz	66 - 56*
0.50 - 5			56
5 - 30			60
0.15 - 0.5	AMN	Average / 9 kHz	56 - 46*
0.50 - 5			46
5 - 30			50

Note:

- (1) The tighter limit applies at the band edges.
- (2) The limit of " * " marked band means the limitation decreases linearly with the logarithm of the frequency in the range.

The following table is the setting of the receiver

Receiver Parameters	Setting
Attenuation	10 dB
Start Frequency	0.15 MHz
Stop Frequency	30 MHz
IF Bandwidth	9 kHz

3.1.3 TEST PROCEDURE

- a. The EUT was placed 0.4 meters from the horizontal ground plane with EUT being connected to the power mains through a line impedance stabilization network (LISN). All other support equipment powered from additional LISN(s). The LISN provide 50 Ohm/ 50uH of coupling impedance for the measuring instrument.
- b. Interconnecting cables that hang closer than 40 cm to the ground plane shall be folded back and forth in the center forming a bundle 30 to 40 cm long.
- c. I/O cables that are not connected to a peripheral shall be bundled in the center. The end of the cable may be terminated, if required, using the correct terminating impedance. The overall length shall not exceed 1 m.
- d. For the actual test configuration, please refer to the related Item –EUT Test Photos.

3.1.4 TEST SETUP

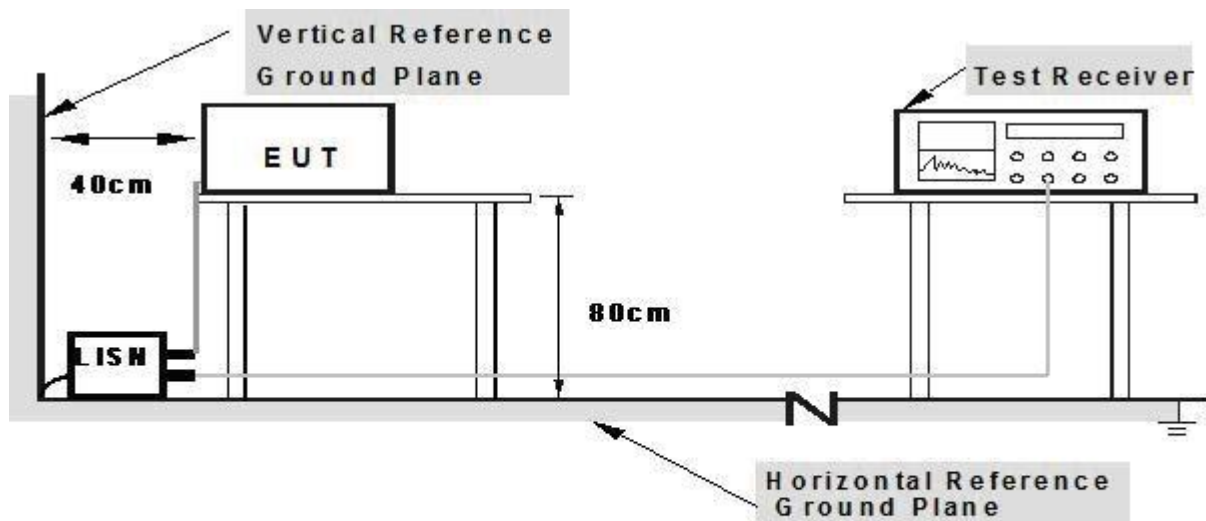

Note: 1. Support units were connected to second LISN.

2. Both of LISN s (AMN) are 80 cm from EUT and at least 80 from other units and other metal planes

3.1.5 EUT OPERATING CONDITIONS

The EUT tested system was configured as the statements of 2.3 Unless otherwise a special operating condition is specified in the following during the testing.

3.1.6 TEST RESULTS

Temperature:	25.3°C	Relative Humidity:	62%
Phase:	L	Test Mode:	Mode 1
Test Voltage:	AC 230V/50Hz		

No.	Frequency (MHz)	Reading (dBuV)	Correct Factor(dB/m)	Result (dBuV/m)	Limit (dBuV/m)	Margin (dB)	Remark
1	0.1773	31.54	9.53	41.07	64.61	23.54	QP
2	0.1773	10.23	9.53	19.76	57.19	37.43	AVG
3	0.2241	24.88	9.53	34.41	62.67	28.26	QP
4	0.2241	5.84	9.53	15.37	54.67	39.30	AVG
5	0.2670	20.70	9.54	30.24	61.21	30.97	QP
6	0.2670	4.08	9.54	13.62	52.77	39.15	AVG
7	4.1544	15.56	9.59	25.15	56.00	30.85	QP
8	4.1544	1.99	9.59	11.58	46.00	34.42	AVG
9	10.3749	15.30	9.64	24.94	60.00	35.06	QP
10	10.3749	4.79	9.64	14.43	50.00	35.57	AVG
11	21.2910	15.38	9.76	25.14	60.00	34.86	QP
12	21.2910	6.45	9.76	16.21	50.00	33.79	AVG

Remark:

1. All readings are Quasi-Peak and Average values.

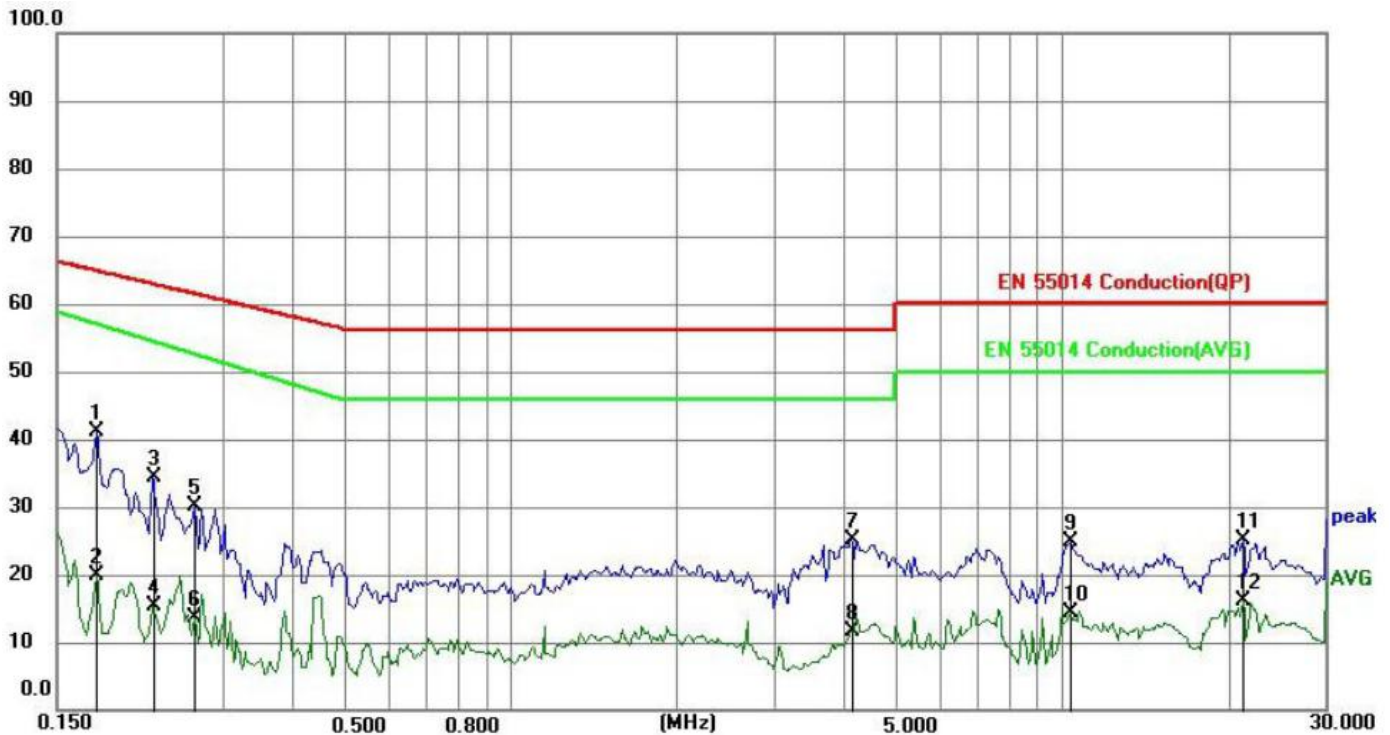



Temperature:	25.3°C	Relative Humidity:	62%
Phase:	N	Test Mode:	Mode 1
Test Voltage:	AC 230V/50Hz		

No.	Frequency (MHz)	Reading (dBuV)	Correct Factor(dB/m)	Result (dBuV/m)	Limit (dBuV/m)	Margin (dB)	Remark
1	0.1617	37.02	9.51	46.53	65.38	18.85	QP
2	0.1617	9.91	9.51	19.42	58.19	38.77	AVG
3	0.1812	36.60	9.52	46.12	64.43	18.31	QP
4	0.1812	19.06	9.52	28.58	56.96	28.38	AVG
5	0.2241	29.72	9.53	39.25	62.67	23.42	QP
6	0.2241	6.83	9.53	16.36	54.67	38.31	AVG
7	1.1952	15.58	9.57	25.15	56.00	30.85	QP
8	1.1952	3.22	9.57	12.79	46.00	33.21	AVG
9	4.0959	18.88	9.63	28.51	56.00	27.49	QP
10	4.0959	3.27	9.63	12.90	46.00	33.10	AVG
11	22.5468	19.56	9.84	29.40	60.00	30.60	QP
12	22.5468	10.23	9.84	20.07	50.00	29.93	AVG

Remark:

1. All readings are Quasi-Peak and Average values.

100.0

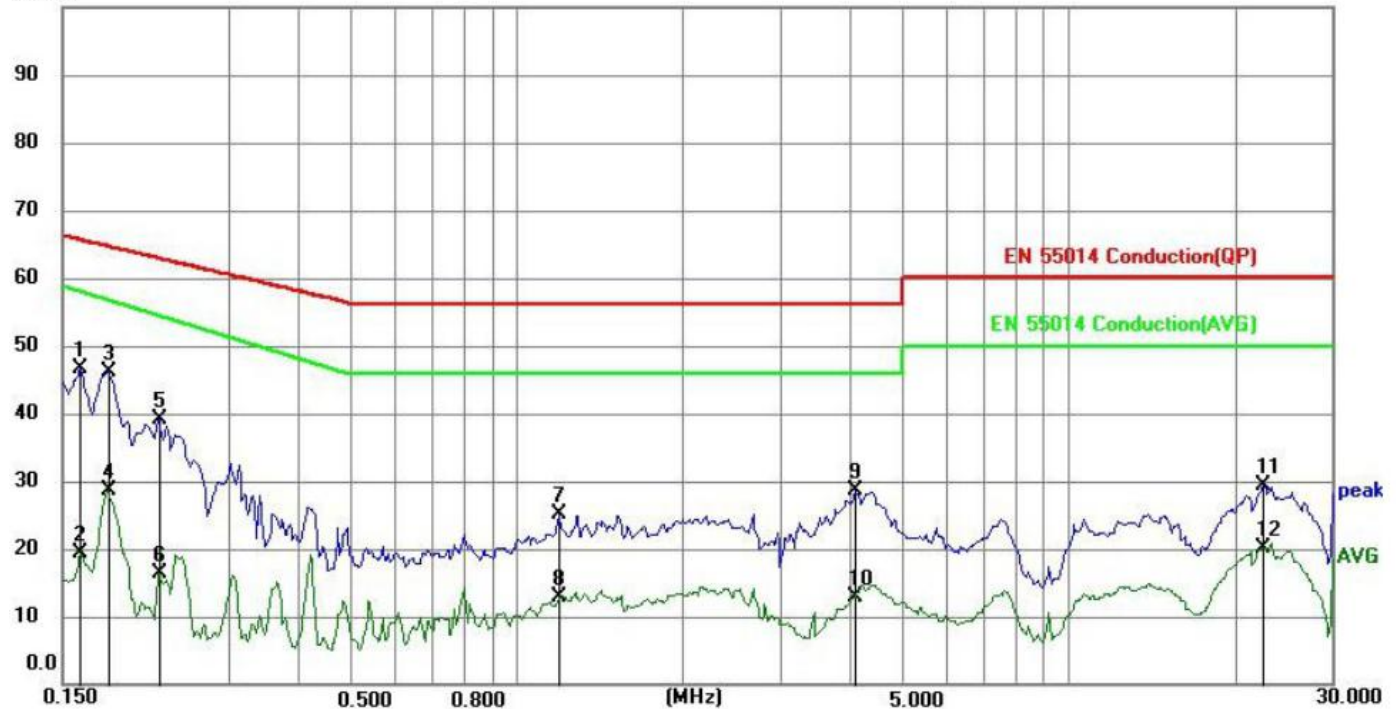

3.2 RADIATED EMISSION MEASUREMENT

3.2.1 LIMITS OF THE RADIATED EMISSION MEASUREMENT

FREQUENCY (MHz)	Distance (m)	Detector type/ bandwidth	Class A	Class B
			dBuV/m	dBuV/m
30 - 230	3	Quasi peak/ 120 kHz	50	40
230 - 1000	3	Quasi peak/ 120 kHz	57	47
1000 - 3000	3	Peak /1 MHz	76	70
3000 - 6000	3	Peak /1 MHz	80	74
1000 - 3000	3	AV/1 MHz	56	50
3000 - 6000	3	AV/1 MHz	60	54

Notes:

- (1) The tighter limit applies at the band edges.
- (2) Emission level (dBuV/m) = 20log Emission level (uV/m).

3.2.3 TEST PROCEDURE

- a. The EUT was placed on the top of a rotating table 0.8 meters above the ground at a 3 meter semi-anechoic chamber room. The table was rotated 360 degrees to determine the position of the highest radiation.
- b. The EUT was set 3 meters away from the interference-receiving antenna, which was mounted on the top of a variable-height antenna tower.
- c. The height of antenna is varied from 1 meter to 4 meters above the ground to determine the maximum value of the field strength. Both horizontal and vertical polarizations of the antenna are set to make the measurement.
- d. For each suspected emission, the EUT was arranged to its worst case and then the antenna was tuned to heights from 1 meter to 4 meters and the rotatable table was turned from 0 degrees to 360 degrees to find the maximum reading.
- e. The test-receiver system was set to quasi-peak detect function and specified bandwidth with maximum hold mode when the test frequency is below 1GHz.
- f. For the actual test configuration, please refer to the related Item –EUT Test Photos.

3.2.4 TEST SETUP

(A) Radiated Emission Test Set-Up Frequency Below 1 GHz

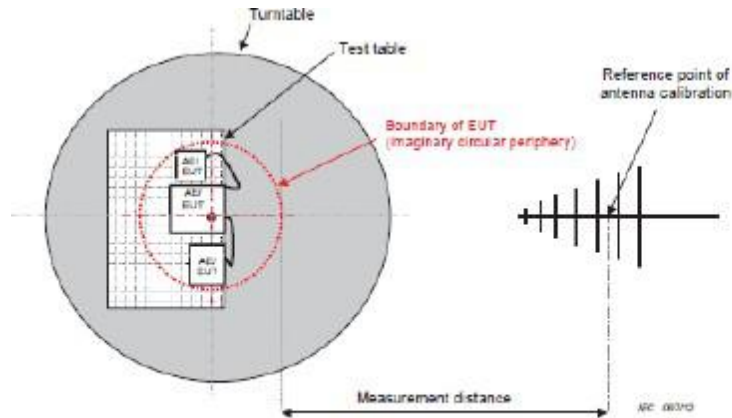

Figure C.1 – Measurement distance

(B) Radiated Emission Test Set-Up Frequency Above 1GHz

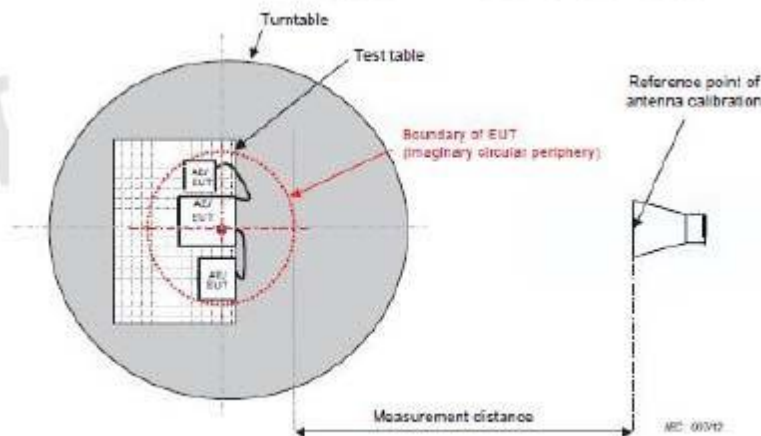

Figure C.1 – Measurement distance

3.2.5 EUT OPERATING CONDITIONS

The EUT tested system was configured as the statements of 2.3 Unless otherwise a special operating condition is specified in the following during the testing.

3.2.6 TEST RESULTS

Temperature:	24.4°C	Relative Humidity:	51%
Phase:	Horizontal	Test Mode:	Mode 1
Test Voltage:	AC 230V/50Hz		

No.	Frequency (MHz)	Reading (dBuV)	Correct Factor(dB/m)	Result (dBuV/m)	Limit (dBuV/m)	Margin (dB)	Remark
1	49.7068	32.03	-6.69	25.34	40.00	-14.66	QP
2	99.8777	33.22	-10.10	23.12	40.00	-16.88	QP
3	166.0680	36.57	-6.68	29.89	40.00	-10.11	QP
4	199.9856	45.45	-10.34	35.11	40.00	-4.89	QP
5	252.0627	50.07	-8.63	41.44	47.00	-5.56	QP
6	292.0583	48.70	-7.61	41.09	47.00	-5.91	QP

Remark:

1. All readings are Quasi-Peak.
2. Margin = Result (Result =Reading + Factor)–Limit
3. Factor= Cable Loss +Antenna Factor–Amplifier Gain



Temperature:	24.4°C	Relative Humidity:	51%
Phase:	Vertical	Test Mode:	Mode 1
Test Voltage:	AC 230V/50Hz		

No.	Frequency (MHz)	Reading (dBuV)	Correct Factor(dB/m)	Result (dBuV/m)	Limit (dBuV/m)	Margin (dB)	Remark
1	99.8777	37.68	-10.19	27.49	40.00	-12.51	QP
2	166.0680	38.96	-6.77	32.19	40.00	-7.81	QP
3	233.3487	42.75	-9.04	33.71	47.00	-13.29	QP
4	325.5958	42.17	-6.89	35.28	47.00	-11.72	QP
5	399.0302	44.58	-5.61	38.97	47.00	-8.03	QP
6	665.8035	41.60	-1.04	40.56	47.00	-6.44	QP

Remark:

1. All readings are Quasi-Peak.
2. Margin = Result (Result =Reading + Factor)–Limit
3. Factor= Cable Loss +Antenna Factor–Amplifier Gain

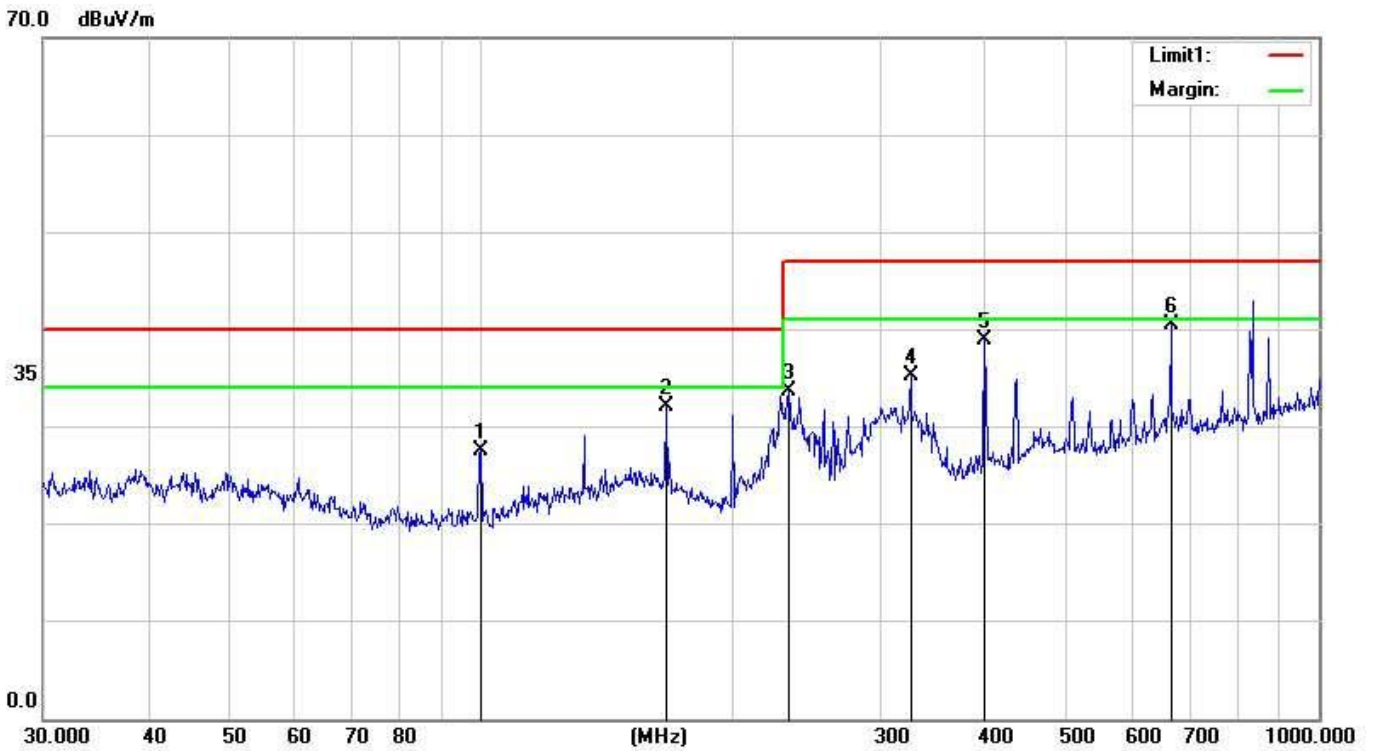

3.3 HARMONICS CURRENT

3.3.1 LIMITS OF THE HARMONICS CURRENT

IEC 555-2					
Table - I			Table - II		
Equipment Category	Harmonic Order n	Max. Permissible Harmonic Current (in Amperes)	Equipment Category	Harmonic Order n	Max. Permissible Harmonic Current (in Amperes)
Non Portable Tools or TV Receivers	Odd Harmonics		TV Receivers	Odd Harmonics	
	3	2.30		3	0.80
	5	1.14		5	0.60
	7	0.77		7	0.45
	9	0.40		9	0.30
	11	0.33		11	0.17
	13	0.21		13	0.12
	15 ≤ n ≤ 39	0.15 · 15/n		15 ≤ n ≤ 39	0.10 · 15/n
	Even Harmonics			Even Harmonics	
	2	1.08		2	0.30
4	0.43	4	0.15		
8	0.30				
8 ≤ n ≤ 40	0.23 · 8/n	DC	0.05		

EN 61000-3-2/IEC 61000-3-2					
Equipment Category	Max. Permissible Harmonic Current (in Amperes)	Equipment Category	Harmonic Order n	Max. Permissible Harmonic Current (in A) (mA/w)	
Class A	Same as Limits Specified in 4-2.1, Table - I, but only odd harmonics required	Class D	3	2.30	3.4
			5	1.14	1.9
			7	0.77	1.0
			9	0.40	0.5
			11	0.33	0.35
			13 ≤ n ≤ 39	see Table I	3.85/n
only odd harmonics required					

3.3.2 TEST PROCEDURE

a. The EUT was placed on the top of a wooden table 0.8 meters above the ground and operated to produce the maximum harmonic components under normal operating conditions.

b. The classification of EUT is according to section 5 of EN 61000-3-2. The EUT is classified as follows:

Class A: Balanced three-phase equipment, Household appliances excluding equipment as Class D, Tools excluding portable tools, Dimmers for incandescent lamps, audio equipment, equipment not specified in one of the three other classes.

Class B: Portable tools. Portable tools.; Arc welding equipment which is not professional equipment.

Class C: Lighting equipment.

Class D: Equipment having a specified power less than or equal to 600W of the following types: Personal computers and personal computer monitors and television receivers.

c. The correspondent test program of test instrument to measure the current harmonics emanated from EUT is chosen. The measure time shall be not less than the time necessary for the EUT to be exercised.

3.3.3 EUT OPERATING CONDITIONS

The EUT tested system was configured as the statements of 2.3 Unless otherwise a special operating condition is specified in the following during the testing.

3.3.4 TEST SETUP

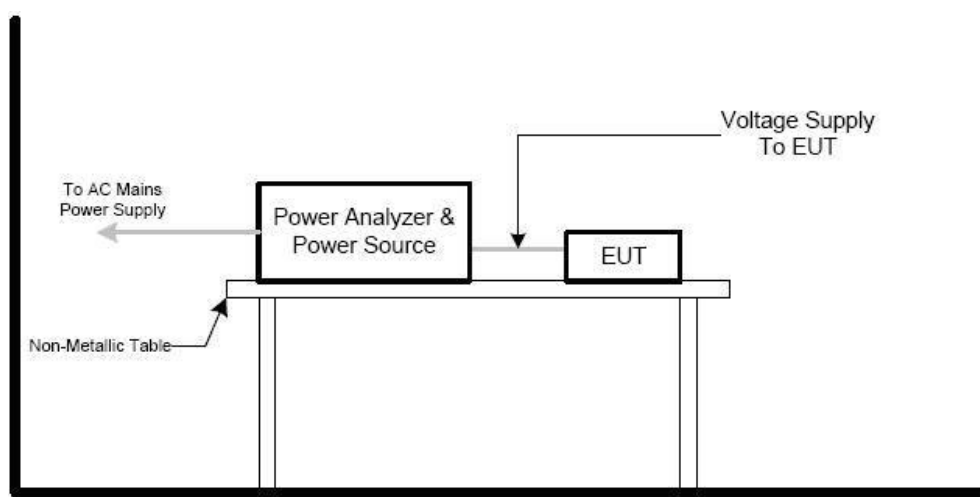



3.3.5 TEST RESULTS

Temperature:	26°C	Relative Humidity:	45%
Test Voltage:	N/A		

Note: The above limits for all equipment except for lighting equipment having an active input power > 75 W and no limits apply for equipment with an active input power up to and including 75W..

3.4 VOLTAGE FLUCTUATION AND FLICKERS

3.4.1 LIMITS OF THE VOLTAGE FLUCTUATION AND FLICKERS

Tests	Measurement Value	Limit	Descriptions
	IEC555-3	IEC/EN 61000-3-3	
P _{st}	≤ 1.0, T _p = 10 min.	≤ 1.0, T _p = 10 min.	Short Term Flicker Indicator
P _{lt}	N/A	≤0.65, T _p =2 hr.	Long Term Flicker Indicator
T _{dt(s)}	≤ 3%	≤ 3.3%	Relative Steady-State V-Chang
d _{max} (%)	≤ 4%	≤ 4%	Maximum Relative V-Chang
d _c (%)	N/A	≤ 3.3% for > 500ms	Relative V-change Characteristic

3.4.2 TEST PROCEDURE

a. Fluctuation and Flickers Test:

Tests was performed according to the Test Conditions/Assessment of Voltage Fluctuations specified in Clause 5.0/6.0 of IEC555-3 and/or Clause 6.0/4.0 of IEC/EN 61000-3-3 depend on which standard adopted for compliance measurement.

b. All types of voltage fluctuation in this report are assessed by direct measurement using flicker-meter.

3.4.3 EUT OPERATING CONDITIONS

The EUT tested system was configured as the statements of 2.3 Unless otherwise a special operating condition is specified in the following during the testing.

3.4.4 TEST SETUP

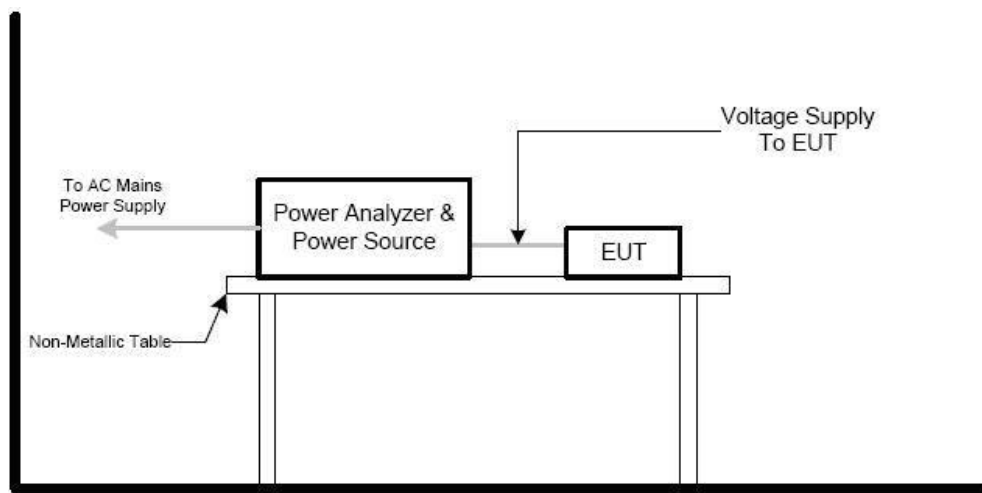



3.4.5 TEST RESULTS

Temperature:	23.9 °C	Relative Humidity:	54%
Test Voltage:	AC 230V/50Hz		

Test Parameter	Measurement Value	Limit	Remarks
P _{st}	0.00	1.0	Pass
P _{It}	--	0.65	--
T _{dt(s)}	0.00	0.5	Pass
d _{max} (%)	0.00%	4%	Pass
d _c (%)	0.00%	3.3%	Pass

4. EMC IMMUNITY TEST

4.1 STANDARD COMPLIANCE/SERVIRITY LEVEL/CRITERIA

Tests Standard No.	TEST SPECIFICATION	Test Mode Test Ports	Perform. Criteria
1. ESD IEC/EN 61000-4-2	8KV air discharge 4KV contact discharge	Direct Mode	B
	4KV HCP discharge 4KV VCP discharge	Indirect Mode	B
2. RS IEC/EN 61000-4-3	80 MHz - 1000 MHz, 1800MHz, 2600MHz, 3500MHz, 5000MHz, 1000Hz, 80%, AM modulated	Enclosure	A
3. EFT/Burst IEC/EN 61000-4-4	5/50ns Tr/Th 5KHz Repetition Freq.	Power Supply Port	B
	5/50ns Tr/Th 5KHz Repetition Freq.	CTL/Signal Data Line Port	B
4. Surges IEC/EN 61000-4-5	1.2/50(8/20) Tr/Th us	L-N	B
	1.2/50(8/20) Tr/Th us	L-PE N-PE	B
5. Injected Current IEC/EN 61000-4-6	0.15 MHz to 80 MHz, 1000Hz 80%, AM Modulated 150Ω source impedance	CTL/Signal Port	A
	0.15 MHz to 80 MHz, 1000Hz 80%, AM Modulated 150Ω source impedance	AC Power Port	A
	0.15 MHz to 80 MHz, 1000Hz 80%, AM Modulated 150Ω source impedance	DC Power Port	A
6. Volt. Interruptions Volt. Dips IEC/EN 61000-4-11	Voltage dip 100%	AC Power Port	B
	Voltage dip 30%		C
	Interruption 100%		C

4.2 GENERAL PERFORMANCE CRITERIA

According to **EN 55014** standard, the general performance criteria as following:

<p>Criterion A</p>	<p>The equipment shall continue to operate as intended without operator intervention. No degradation of performance, loss of function or change of operating state is allowed below a performance level specified by the manufacturer when the equipment is used as intended. The performance level may be replaced by a permissible loss of performance. If the minimum performance level or the permissible performance loss is not specified by the manufacturer, then either of these may be derived from the product description and documentation, and by what the user may reasonably expect from the equipment if used as intended.</p>
<p>Criterion B</p>	<p>During the application of the disturbance, degradation of performance is allowed. However, no unintended change of actual operating state or stored data is allowed to persist after the test.</p> <p>After the test, the equipment shall continue to operate as intended without operator intervention; no degradation of performance or loss of function is allowed, below a performance level specified by the manufacturer, when the equipment is used as intended. The performance level may be replaced by a permissible loss of performance.</p> <p>If the minimum performance level (or the permissible performance loss), or recovery time, is not specified by the manufacturer, then either of these may be derived from the product description and documentation, and by what the user may reasonably expect from the equipment if used as intended.</p>
<p>Criterion C</p>	<p>Loss of function is allowed, provided the function is self-recoverable, or can be restored by the operation of the controls by the user in accordance with the manufacturer's instructions. A reboot or re-start operation is allowed.</p> <p>Information stored in non-volatile memory, or protected by a battery backup, shall not be lost.</p>

4.2.1 GENERAL PERFORMANCE CRITERIA TEST SETUP

The EUT tested system was configured as the statements of **2.3** Unless otherwise a special operating condition is specified in the following during the testing.

4.3 ELECTROSTATIC DISCHARGE IMMUNITY TEST (ESD)

4.3.1 TEST SPECIFICATION

Basic Standard:	IEC/EN 61000-4-2
Discharge Impedance:	330 ohm / 150 pF
Required Performance:	B
Discharge Voltage:	Air Discharge: 2KV/4KV/8KV (Direct) Contact Discharge: 2KV/4KV (Direct/Indirect)
Polarity:	Positive & Negative
Number of Discharge:	Air Discharge: min. 20 times at each test point Contact Discharge: min. 200 times in total 20 times at each test point
Discharge Mode:	Single Discharge
Discharge Period:	1 second minimum

4.3.2 TEST PROCEDURE

The test generator necessary to perform direct and indirect application of discharges to the EUT in the following manners:

- a. Electrostatic discharges were applied only to those points and surfaces of the EUT that are accessible to users during normal operation
The test was performed with at least ten single discharges on the pre-selected points in the most sensitive polarity.

The time interval between two successive single discharges was at least 1 second.

The ESD generator was held perpendicularly to the surface to which the discharge was applied and the return cable was at least 0.2 meters from the EUT.

Contact discharges were applied to the non-insulating coating, with the pointed tip of the generator penetrating the coating and contacting the conducting substrate.

Air discharges were applied with the round discharge tip of the discharge electrode approaching the EUT as fast as possible (without causing mechanical damage) to touch the EUT. After each discharge, the ESD generator was removed from the EUT and re-triggered for a new single discharge. The test was repeated until all discharges were complete.

Vertical Coupling Plane (VCP):

The coupling plane, of dimensions 0.5m x 0.5m, is placed parallel to, and positioned at a distance 0.1m from, the EUT, with the Discharge Electrode touching the coupling plane.

The four faces of the EUT will be performed with electrostatic discharge.

Horizontal Coupling Plane (HCP):

The coupling plane is placed under to the EUT. The generator shall be positioned vertically at a distance of 0.1m from the EUT, with the Discharge Electrode touching the coupling plane.

The four faces of the EUT will be performed with electrostatic discharge.

- b. Air discharges at insulation surfaces of the EUT.

It was at least ten single discharges with positive and negative at the same selected point.

4.3.3 TEST SETUP

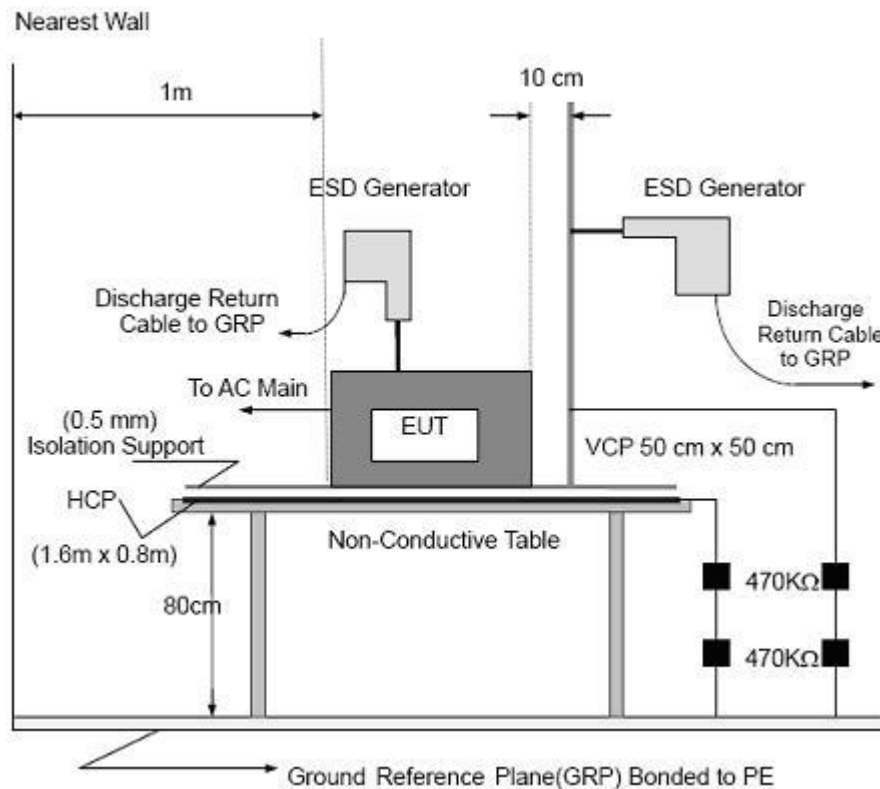

Note:

TABLE-TOP EQUIPMENT

The configuration consisted of a wooden table 0.8 meters high standing on the Ground Reference Plane. The GRP consisted of a sheet of aluminum at least 0.25mm thick. A Horizontal Coupling Plane (1.6m x 0.8m) was placed on the table and attached to the GRP by means of a cable with 940kΩ total impedance. The equipment under test, was installed in a representative system as described in section 7 of IEC /EN 61000-4-2, and its cables were placed on the HCP and isolated by an insulating support of 0.5mm thickness. A distance of 0.8-meter minimum was provided between the EUT and the walls of the laboratory and any other metallic structure.

FLOOR-STANDING EQUIPMENT

The equipment under test was installed in a representative system as described in section 7 of IEC/EN 61000-4-2, and its cables were isolated from the Ground Reference Plane by an insulating support of 0.1 meter thickness. The GRP was consisted of a sheet of aluminum that is at least 0.25mm thick, and extended at least 0.5 meters from the EUT on all sides.

4.3.4 TEST RESULTS

Temperature:	23.9°C	Relative Humidity:	56%
Pressure:	1020.1hPa	Test Voltage:	AC 230V/50Hz
Test Mode:	Mode1		

Discharge Level	Polarity	Test Points	Contact Discharge	Air Discharge	Criterion	Test Result
4	+/-	VCP/HCP	NOTE	N/A	A	PASS
2,4	+/-	Green Dot	N/A	N/A	A	PASS
2,4,8	+/-	Red Dot	N/A	NOTE	A	PASS

Note: The EUT function was correct during the test.
 Red Dot —Air Discharged
 Green Dot —Contact Discharged

4.4 RADIATED, RADIO-FREQUENCY, ELECTROMAGNETIC FIELD IMMUNITY TEST (RS)

4.4.1 TEST SPECIFICATION

Basic Standard:	IEC/EN 61000-4-3
Required Performance:	A
Frequency Range:	80 MHz - 6GHz
Field Strength:	3 V/m
Modulation:	1kHz Sine Wave, 80%, AM Modulation
Frequency Step:	1 % of fundamental
Polarity of Antenna:	Horizontal and Vertical
Test Distance:	3 m
Antenna Height:	1.5 m
Dwell Time:	1.5x 10 ⁻³ decade/s

4.4.2 TEST PROCEDURE

- a. The testing was performed in a fully anechoic chamber. The transmit antenna was located at a distance of 3 meters from the EUT.
- b. The frequency range is swept from 80 MHz to 1000 MHz, 1800 MHz, 2600 MHz, 3500 MHz, 5000 MHz, with the signal 80% amplitude modulated with a 1kHz sine-wave. The rate of sweep did not exceed 1.5 x 10⁻³ decade/s, where the frequency range is swept incrementally, the step size was 1% of preceding frequency value.
- c. The dwell time at each frequency shall be not less than the time necessary for the EUT to be able to respond.
- e. The test was performed with the EUT exposed to both vertically and horizontally polarized fields on each of the four sides.

4.4.3 TEST SETUP

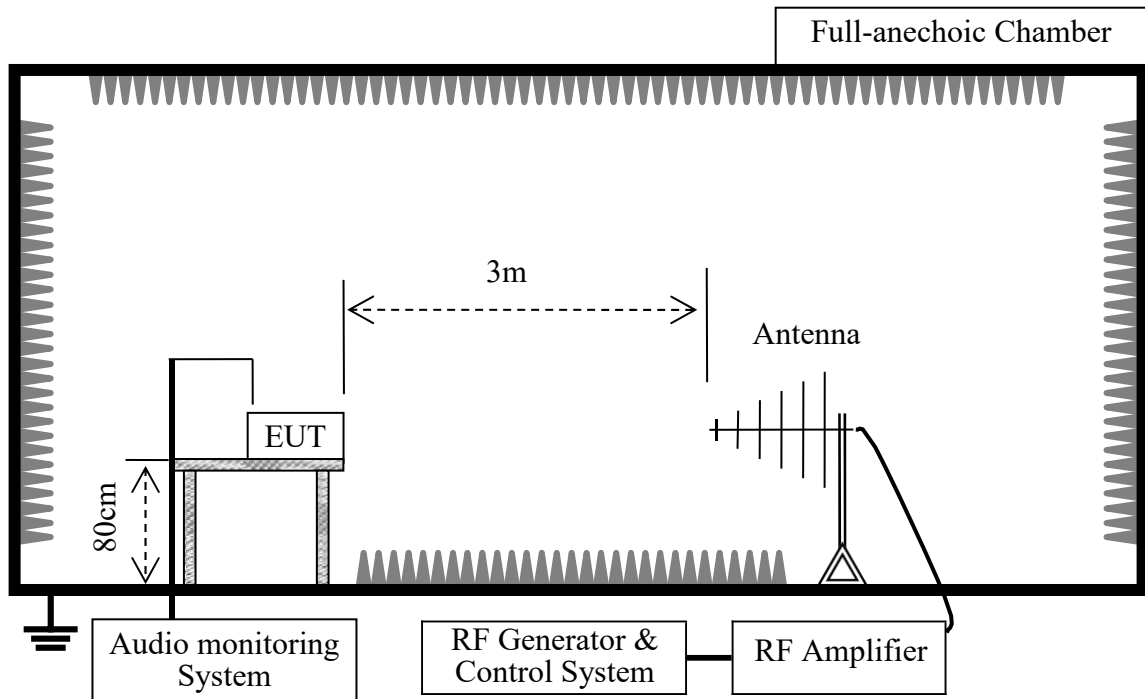

Note:

TABLE-TOP EQUIPMENT

The EUT installed in a representative system as described in section 7 of IEC/EN 61000-4-3 was placed on a non-conductive table 0.8 meters in height. The system under test was connected to the power and signal wire according to relevant installation instructions.

FLOOR-STANDING EQUIPMENT

The EUT installed in a representative system as described in section 7 of IEC/EN 61000-4-3 was placed on a non-conductive wood support 0.1 meters in height. The system under test was connected to the power and signal wire according to relevant installation instructions.

For Audio output function use below setting

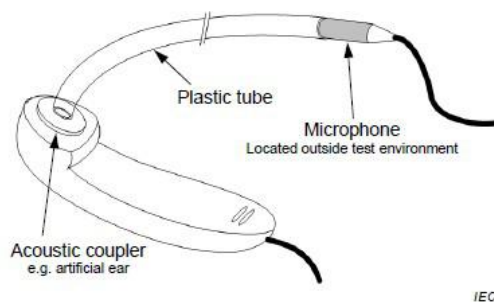

NOTE 1 The microphone is connected via the cable to a suitable amplifier.

NOTE 2 This setup is suitable for radiated immunity testing. See G.6.3

Figure G.5 – Example test setup for on-ear acoustic measurements, microphone located away from earpiece transducer

**4.4.4 TEST RESULTS**

Temperature:	23.9°C	Relative Humidity:	54%
Test Voltage:	AC 230V/50Hz	Test Mode:	Mode1

Frequency Range (MHz)	RF Field Position	R.F. Field Strength	Azimuth	Perform. Criteria	Results	Judgment
80MHz - 6GHz	H / V	3 V/m (rms) AM Modulated 1000Hz, 80%	Front	A	A	PASS
			Rear			
			Left			
			Right			

4.5 ELECTRICAL FAST TRANSIENT (EFT)

4.5.1 TEST SPECIFICATION

Basic Standard:	IEC/EN 61000-4-4
Required Performance:	B
Test Voltage:	Power Line: 1 KV Signal/Control Line: 0.5 KV DC network power port:0.5KV
Polarity:	Positive & Negative
Impulse Frequency:	5 kHz
Impulse Wave shape :	5/50 ns
Burst Duration:	15ms
Burst Period:	300ms
Test Duration:	Not less than 1 min.

4.5.2 TEST PROCEDURE

The EUT and support equipment, are placed on a table that is 0.8 meter&0.1 meter above a metal ground plane measured 1m*1m min .

The ground reference plane shall be a metallic sheet (copper or aluminum) of 0.25 mm minimum thickness; other metallic materials may be used, but they shall have at least 0.65 mm minimum thickness.

The other condition need as following manners:

- c. The length of power cord between the coupling device and the EUT should not exceed 1 meter.
- d. Both positive and negative polarity discharges were applied.
- e. The duration time of each test sequential was 1 minute

4.5.3 TEST SETUP

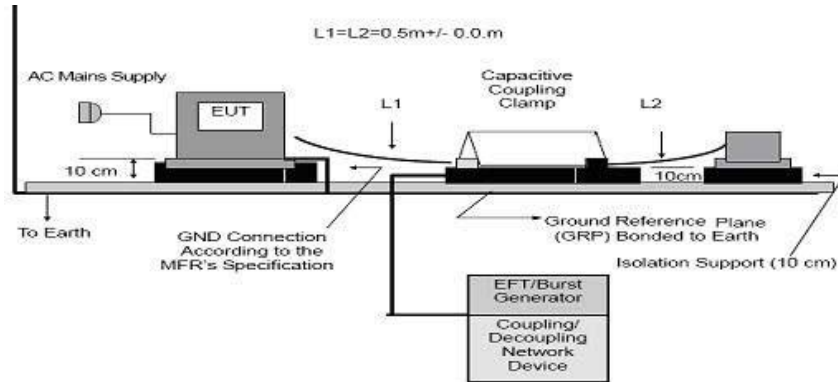
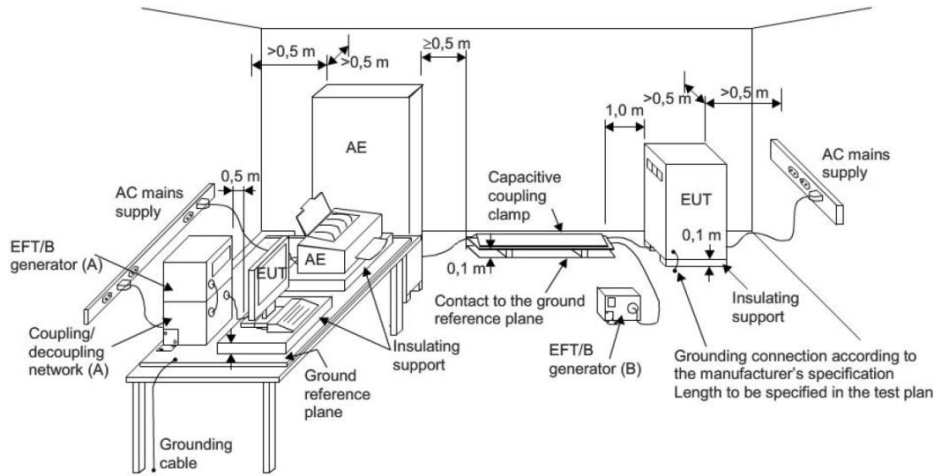

Note:

TABLE-TOP EQUIPMENT

Table-top equipment and equipment normally mounted on ceilings or walls as well as built-in equipment shall be tested with the EUT located (0.1 ± 0.01) m above the ground reference plane. Testing of large table-top equipment or multiple systems can be performed on the floor; maintaining the same distances as for the test setup of table-top equipment.

The test generator and the coupling/decoupling network shall be bonded to the ground reference plane.

The ground reference plane shall be a metallic sheet (copper or aluminum) of 0.25 mm minimum thickness; other metallic materials may be used, but they shall have at least 0.65 mm minimum thickness.

The minimum size of the ground reference plane is 0.8 m x 1 m. The actual size depends on the dimensions of the EUT.

The ground reference plane shall project beyond the EUT by at least 0.1 m on all sides.

The ground reference plane shall be connected to the earth (PE) for safety reasons.

The EUT shall be arranged and connected to satisfy its functional requirements, according to the equipment installation specifications.

The minimum distance between the EUT and all other conductive structures (including the generator, AE and the walls of a shielded room), except the ground reference plane, shall be more than 0.5 m.

All cables to the EUT shall be placed on the insulation support 0.1 m above the ground reference plane. Cables not subject to electrical fast transients shall be routed as far as possible from the cable under test to minimize the coupling between the cables.

The EUT shall be connected to the earth system in accordance with the manufacturer's installation specifications; no additional earth connections are allowed.

The connection impedance of the coupling/decoupling network earth cables to the ground reference plane and all connectors shall provide a low inductance.

Either a direct coupling network or a capacitive clamp shall be used for the application of the test voltages. The test voltages shall be coupled to all of the EUT ports in turn including those between two units of equipment involved in the test, unless the length of the interconnecting cable makes it impossible to test.

FLOOR-STANDING EQUIPMENT

When using the coupling clamp, the minimum distance between the coupling plates and all other conductive surfaces (including the generator), except the ground reference plane beneath the coupling clamp and beneath the EUT, shall be at least 0.5 m.

The distance between any coupling devices and the EUT shall be ($0.5 - 0/+0.1$) m for tabletop equipment testing, and (1.0 ± 0.1) m for floor standing equipment, unless otherwise specified in product standards. When it is not physically possible to apply the distances mentioned above, other distances can be used and shall be recorded in the test report.

The cable between the EUT and the coupling device, if detachable, shall be as short as possible to comply with the requirements of this clause. If the manufacturer provides a cable exceeding the distance between the coupling device and the point of entry of the EUT, the excess length of this cable shall be bundled and situated at a distance of 0.1 m above the ground reference plane. When a capacitive clamp is used as a coupling device, the excess cable length shall be bundled at the AE side.

Parts of the EUT with interconnecting cables of a length less than 3 m, which are not tested, shall be placed on the insulating support. The parts of the EUT shall have a distance of 0.5 m between them. Excess cable length shall be bundled.

4.5.4 TEST RESULTS

Temperature:	23.9°C	Relative Humidity:	54%
Test Voltage:	AC 230V/50Hz	Test Mode:	Mode1

Coupling Line		Test level	Perform. Criteria	Results	Judgment
AC line	L	±1KV	A	A	PASS
	N	±1KV		A	PASS
	PE	N/A		N/A	N/A
	L+N	±1KV		A	PASS
	L+PE	N/A		N/A	N/A
	N+PE	N/A		N/A	N/A
	L+N+PE	N/A		N/A	N/A
DC network power port Line		N/A		N/A	N/A
Signal Line		N/A		N/A	N/A

Note: 1) N/A - denotes test is not applicable in this test report.

4.6 SURGE TESTING

4.6.1 TEST SPECIFICATION

Basic Standard:	IEC/EN 61000-4-5
Required Performance:	B
Wave-Shape:	Combination Wave 1.2/50us Open Circuit Voltage
Test Voltage:	Power line ~ line to line: 1 KV line to ground: 2KV Telecommunication line: 0.5KV DC network power port:0.5KV
Surge Input/Output:	L-N, L-PE, N-PE
Generator Source:	(L-N)2 ohm between networks
Impedance:	(L-PE, N-PE)12 ohm between network and ground
Polarity:	Positive/Negative
Phase Angle:	0°/90°/180°/270°
Pulse Repetition Rate:	1 time / min. (maximum)
Number of Tests:	5 positive and 5 negative at selected points

4.6.2 TEST PROCEDURE

- a. For EUT power supply:
- b. The surge is to be applied to the EUT power supply terminals via the capacitive coupling network. Decoupling networks are required in order to avoid possible adverse effects on equipment not under test that may be powered by the same lines, and to provide sufficient decoupling impedance to the surge wave. The power cord between the EUT and the coupling/decoupling networks shall be 2meters in length (or shorter).
- c. For test applied to unshielded unsymmetrically operated interconnection lines of EUT:
- d. The surge is applied to the lines via the capacitive coupling. The coupling /decoupling networks shall not influence the specified functional conditions of the EUT. The interconnection line between the EUT and the coupling/decoupling networks shall be 2 meters in length (or shorter).

4.6.3 TEST SETUP

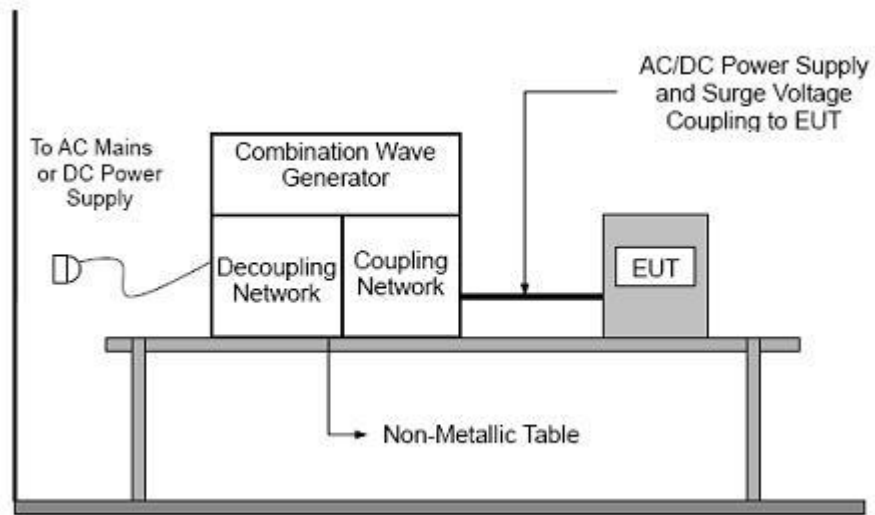

4.6.4 TEST RESULTS

Temperature:	23.9°C	Relative Humidity:	54%
Test Voltage:	AC 230V/50Hz	Test Mode:	Mode1

Coupling Line		Test level	Perform. Criteria	Results	Judgment
AC line	L-N	±1KV	A	A	PASS
	L-PE	N/A		N/A	N/A
	N-PE	N/A		N/A	N/A
DC network power port		N/A		N/A	N/A
Signal Line		N/A		N/A	N/A

Note: 1) N/A - denotes test is not applicable in this test report.

4.7 CONDUCTED RADIO FREQUENCY DISTURBANCES (CS)

4.7.1 TEST SPECIFICATION

Basic Standard:	IEC/EN 61000-4-6
Required Performance:	A
Frequency Range:	0.15 MHz - 10 MHz, 10 MHz - 30 MHz, 30 MHz - 80 MHz
Field Strength:	0.15 MHz - 10 MHz, 3V. 10 MHz - 30 MHz, 3V to 1V. 30 MHz - 80 MHz, 1V
Modulation:	1kHz Sine Wave, 80%, AM Modulation
Frequency Step:	1 % of fundamental
Dwell Time:	1.5x 10 ⁻³ decade/s

4.7.2 TEST PROCEDURE

The EUT shall be tested within its intended operating and climatic conditions.

The test shall be performed with the test generator connected to each of the coupling and decoupling devices in turn, while the other non-excited RF input ports of the coupling devices are terminated by a 50-ohm load resistor.

The frequency range was swept from 150 kHz to 10 MHz, 10 MHz to 30 MHz, 30 MHz to 80 MHz using the signal level established during the setting process and with a disturbance signal of 80 % amplitude. The signal was modulated with a 1 kHz sine wave, pausing to adjust the RF signal level or the switch coupling devices as necessary. The sweep rate was 1.5 x 10⁻³ decades/s. Where the frequency range is swept incrementally, the step size was 1 % of preceding frequency value from 150 kHz to 80 MHz.

The dwell time at each frequency was less than the time necessary for the EUT to be exercised, and able to respond. Sensitive frequencies such as clock frequency (ies) and harmonics or frequencies of dominant interest, was analyzed separately.

Attempts were made to fully exercise the EUT during testing, and to fully interrogate all exercise modes selected for susceptibility.

4.7.3 TEST SETUP

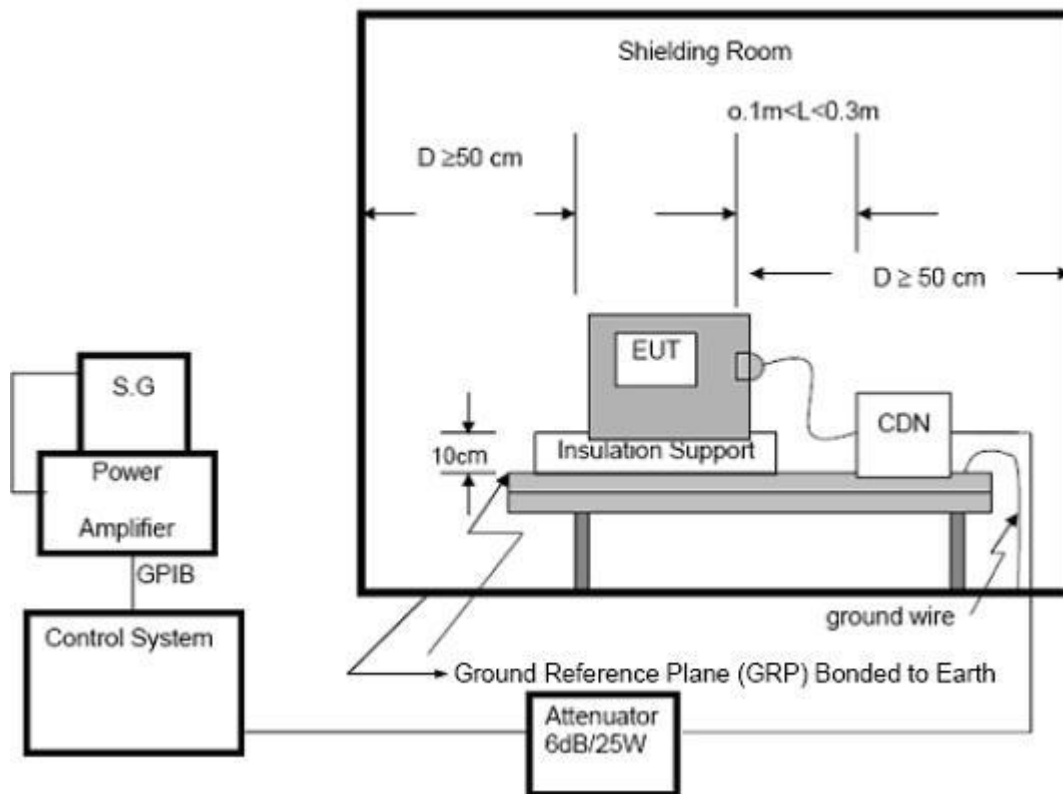

NOTE:

FLOOR-STANDING EQUIPMENT

The equipment to be tested is placed on an insulating support of 0.1 meters height above a ground reference plane. All relevant cables shall be provided with the appropriate coupling and decoupling devices at a distance between 0.1 meters and 0.3 meters from the projected geometry of the EUT on the ground reference plane.

For Audio output function use below setting

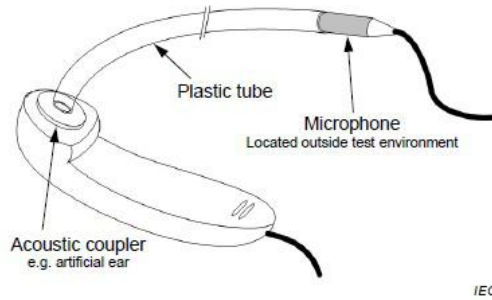

NOTE 1 The microphone is connected via the cable to a suitable amplifier.

NOTE 2 This setup is suitable for radiated immunity testing. See G.6.3

Figure G.5 – Example test setup for on-ear acoustic measurements, microphone located away from earpiece transducer

4.7.4 TEST RESULTS

Temperature:	23.9°C	Relative Humidity:	54%
Test Voltage:	AC 230V/50Hz	Test Mode:	Mode1

Test Ports (Mode)	Freq. Range MHz)	Field Strength	Perform. Criteria	Results	Judgment
Input/ Output AC. Power Port	0.15 - 10	3V(rms) AM Modulated 1000Hz, 80%	A	A	PASS
	10 - 30	3V to 1V(rms) AM Modulated 1000Hz, 80%			
	30 - 80	1V(rms) AM Modulated 1000Hz, 80%			
Input/ Output DC. Power Port	0.15 - 10	3V(rms) AM Modulated 1000Hz, 80%	N/A	N/A	N/A
	10 - 30	3V to 1V(rms) AM Modulated 1000Hz, 80%			
	30 - 80	1V(rms) AM Modulated 1000Hz, 80%			
Signal Line	0.15 - 10	3V(rms) AM Modulated 1000Hz, 80%	N/A	N/A	N/A
	10 - 30	3V to 1V(rms) AM Modulated 1000Hz, 80%			
	30 - 80	1V(rms) AM Modulated 1000Hz, 80%			

Note: 1) N/A - denotes test is not applicable in this test report.

4.8 VOLTAGE INTERRUPTION/DIPS TESTING (DIPS)

4.8.1 TEST SPECIFICATION

Basic Standard:	IEC/EN 61000-4-11
Required Performance:	B (For 100% Voltage Dips, 0.5 Cycle) C (For 30% Voltage Dips, 25 Cycles) C (For 100% Voltage Interruptions, 250 Cycles)
Test Duration Time:	Minimum three test events in sequence
Interval between Event:	Minimum ten seconds
Phase Angle:	0°/45°/90°/135°/180°/225°/270°/315°/360°
Test Cycle:	3 times

4.8.2 TEST PROCEDURE

The EUT shall be tested for each selected combination of test levels and duration with a sequence of three dips/interruptions with intervals of 10 s minimum (between each test event). Each representative mode of operation shall be tested. Abrupt changes in supply voltage shall occur at zero crossings of the voltage waveform.

4.8.3 TEST SETUP

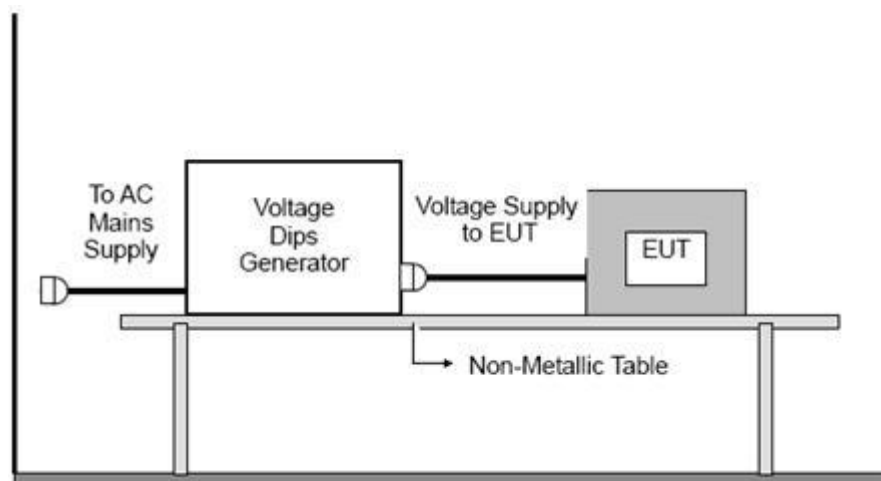



4.8.4 TEST RESULTS

Temperature:	23.9°C	Relative Humidity:	54%
Test Voltage:	AC 230V/50Hz	Test Mode:	Mode1

Voltage Reduction	Duration (cycle)	Perform Criteria	Results	Judgment
Voltage dip 100%	0.5	B	A	PASS
Voltage dip 30%	25	C	A	PASS
Voltage interruptions	250	C	B	PASS

APPENDIX 1- TEST SETUP

RE

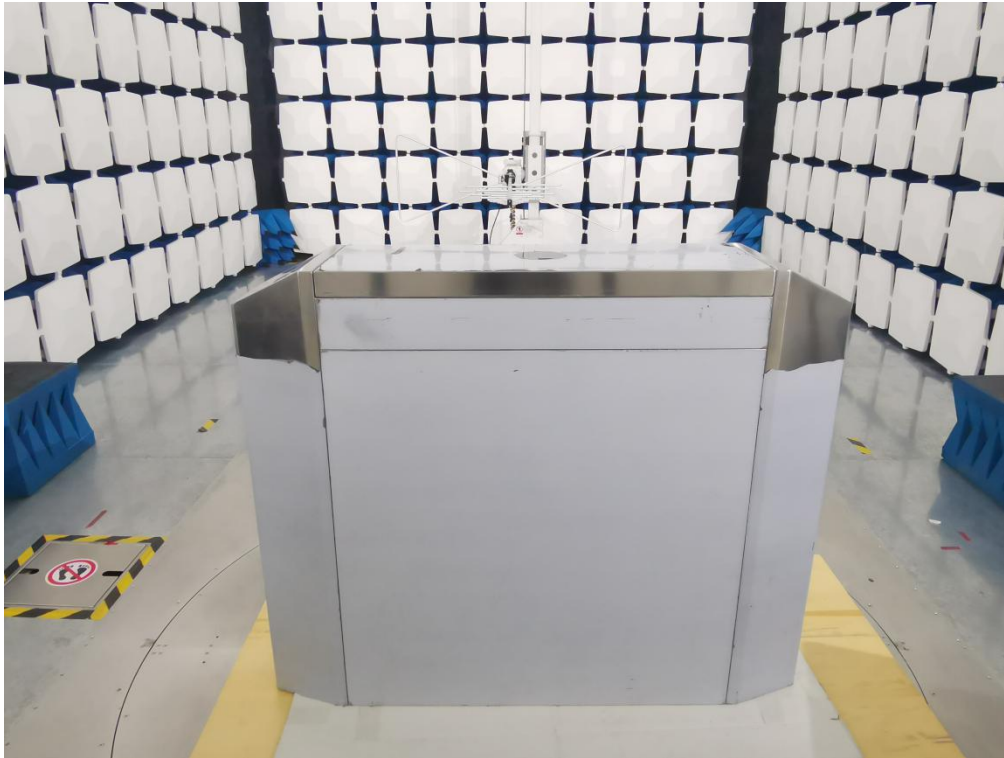

※※※※※END OF THE REPORT※※※※※